

MHD-201

ClassA.
High-Definition Modulator

Modulated signals in HD to
COFDM and IP.

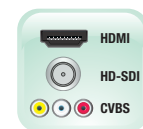

**Multi-Input
Multi-Format**



**Automatic
USB Player
HD contents**



IP Output



COFDM Output



**Editable channel
name and
information to be
shown on the TV set**



This product is compatible with:
Ikusi Headend Discovery

Technical Specifications

Model	MHD-201	
Ref.	3854	
Inputs	(2x) CVBS, HDMI, HD-SDI (non-simultaneous)	
Input level (CVBS)	Vpp	0.7 - 1.4
Input impedance (CVBS)	Ω	75
Video standard	PAL/SECAM/NTSC/B&W	
Audio input	1 (Mono and Stereo)	
Audio input level (analog)	Vpp	0.5 - 2.5
Video compression	MPEG2 MP@ML, H.264/MPEG4 AVC MP L4.1	
Audio compression	MPEG1 layer II	
Video quality	SD, HD (480i, 576i, 480P, 576P, 720p50, 720p, 1080i50, 1080i60, 1080p50, 1080p60)	
Maximum resolution	1080p60	
COFDM Output		
Standard	DVB-T in accordance with ETSI EN 300 744	
Bandwidths	MHz	6 / 7 / 8
Number of carriers	2K / 8K	
MER	dB	≥ 40
Central frequency	MHz	45 - 858
Output level	dB μ V	≥ 80
Output attenuation	dB	0.5
Level adjustment	dB	-25
Frequency stability	ppm	$\leq \pm 30$
Spurious in band	dBc	≤ -60
Noise figure ($\Delta B = 8$ MHz)	dBc	≤ -65
Loophrough frequency	45 MHz to 2.5 GHz	
IP Output		
Interfaz	IEEE 802.3 10/100 Base T	
IP encapsulated type	According to ETSI TS 102 034 v1.31(2007-10) and SMPTE ST 2022-2:2007	
Outflow IP	CBR/VBR	
IP address	Unicast/Multicast	
Protocols	UDP/RTP	
IP encapsulated format	SPTS	
Diffserv QoS	Yes	
Time To Live (TTL)	Yes	
VLAN Tagging	Yes	
SAP service announcement	Yes	
DVB processing	PAT, PMT, SDT, TDT, TOT	
General		
SPI-300 configuration	RS-232	
Web	Ethernet	
NIT and SDT adaptation	Yes	
TS monitoring	Yes	
Network configuration	NID, ONID, TSID, Network name, Provider	
SID configuration	Yes	
LCN, TDT, TOT processing	Yes	
Channel name edition (EIT)	Yes (ex. "camera pool")	
Event description (EIT)	Yes (ex. "open from 9am to 18pm")	
Supply voltage	VDC	+12
Consumption	A	1.3
Firmware upgrade	Web interface	
Playback from USB	Yes	
USB	Yes	
Dimensions	mm	230 x 195 x 32

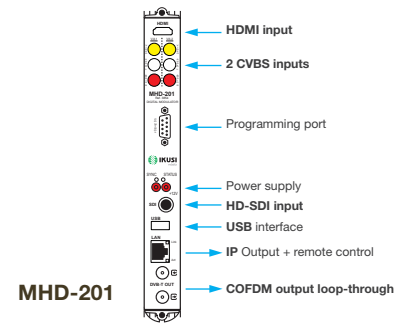

Possible input combinations:

- SD CVBS/Audio + SD CVBS/Audio
 - SD HDMI + SD CVBS/Audio
 - SD SDI + SD CVBS/Audio
 - SD + USB
 - HD HDMI
 - HD SDI
 - HD + USB
- 2 simultaneous SD channels
1 channel SD + USB
- 1 channel HD
1 channel HD + USB

The **MHD-201** is a module designed and manufactured completely with in-house technology, that is able to treat different video and audio formats, to create a high-definition output channel in COFDM and in IP which can be active simultaneously.

The unit has various types of inputs:

- Two analogue audio and video channels, through RCA connectors.
- One digital audio and video channel in HDMI, through an HDMI connection.
- One digital audio and video channel in HD-SDI, through a BNC connector.

This product solution fulfils the needs of video signal distribution in residential facilities, hospitals, hotels and unique buildings and also CCTV integration in existing installations. The MHD-201 has also an USB interface for HD video contents playback from a USB memory automatically.

This functionality allows different applications such as digital signage, creating an information channel or the integration of any source of existing video into the TV network, allowing simultaneously obtaining the video signal plus a modulated channel.

Programming the modulator by:

- Connecting a local or remote web interface.



This product is compatible with PC application: "IKUSI HEADEND DISCOVERY" (download web <http://customerarea.ikusitv.com>).

This utility provides the installer with a tool to automatically determine which computers are on the LAN).

Its professional format allows the installation in a 19 "rack or in a wall frame with high density of channels.







Application examples

Application in residential installations, communal blocks, hotels, hospitals, individual buildings or video security installations.

Allows any business to economically and straightforwardly generate its own advertising and information channel.

Digital signage application. Playback from the USB memory is automatic.

SOME OF THE SUPPORTED VIDEO SOURCES

-  Satellite Channel (IRD)
-  Player channel (DVD)
-  Video surveillance channel
-  Advertising channel (USB)
-  Studio channel

IP output Headend

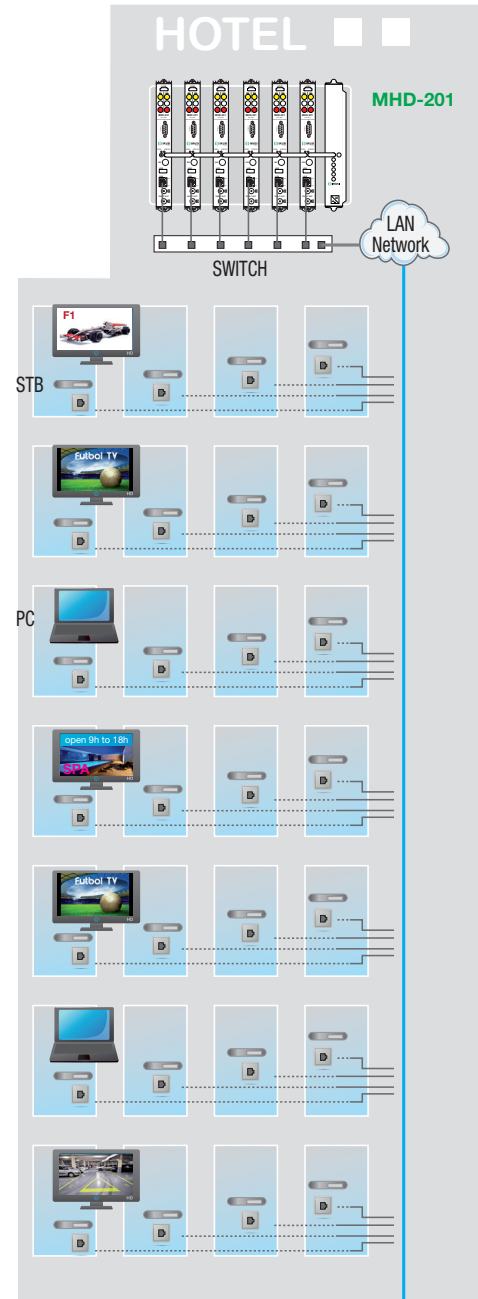

DVB-T output Headend

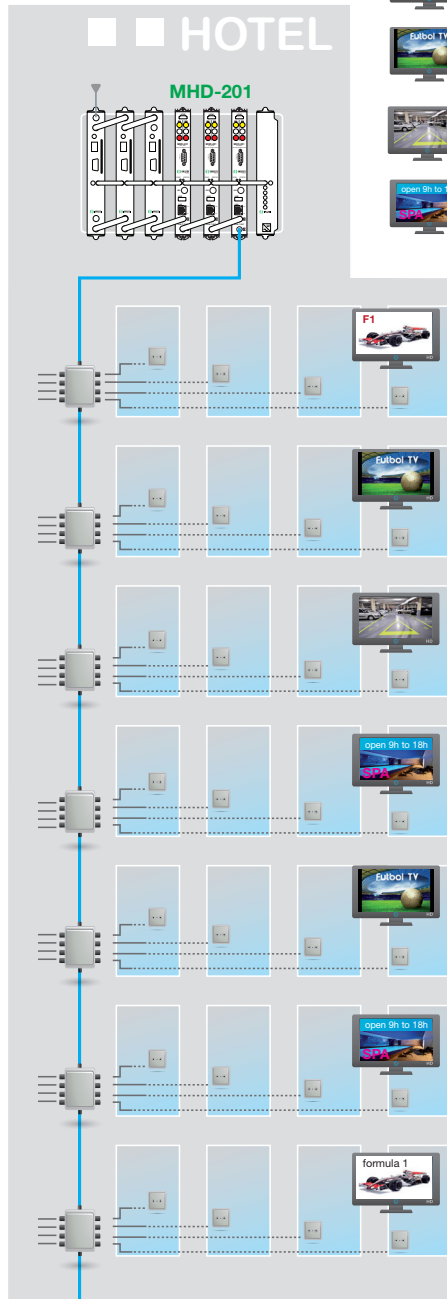

HEADQUARTERS

IKUSI - Ángel Iglesias S.A. · Pº Miramón, 170 · 20014 San Sebastián · SPAIN
Tel.: +34 943 44 88 00 · Fax: +34 943 44 88 20 · television@ikusi.com · www.ikusi.tv

